

**Characteristics**

Double-throttle check valves from the Parker series FM are in sandwich design for easy configuration of stack systems. Throttle and check valves are located in ports A and B.

FM2 and FM3 can be used as meter-in or meter-out throttle by changing the mounting position.

FM4 can be selected by ordering code as meter-in or meter-out throttle. FM6 is only available as meter-out control.

The throttle check valve can also be used to influence the switching time of pilot operated directional valves. In this case, the valve is positioned between the pilot stage (CETOP 03, NG06) and the main stage (CETOP 05, NG10 up to CETOP 10, NG32).

**Features**

- The metering needle design allows a very wide range of flows to be suitable for all applications, from very sensitive adjustments of low flow up to maximum flow.
- Large bypass check valves allow high flow at low pressure drop.
- NG06 - FM2 (CETOP 03)  
NG10 - FM3 (CETOP 05)  
NG16 - FM4 (CETOP 07)  
NG25 - FM6 (CETOP 08)

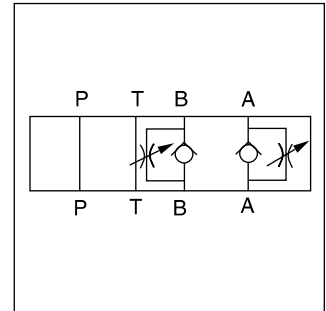

FM3

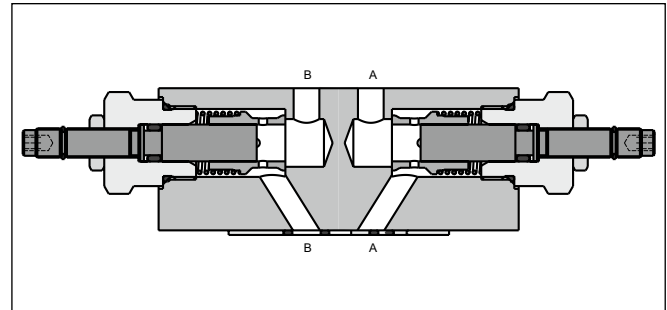

**Technical data**

General		FM2	FM3	FM4	FM6
Series		<b>FM2</b>	<b>FM3</b>	<b>FM4</b>	<b>FM6</b>
Size		<b>NG06</b>	<b>NG10</b>	<b>NG16</b>	<b>NG25</b>
Mounting interface		NFPA D03 CETOP 03	NFPA D05 CETOP 05	NFPA D07 CETOP07	NFPA D08 CETOP 08
Mounting position		unrestricted			
Ambient temperature	[°C]	-20...+70			
MTTF <sub>D</sub> value	[years]	150			
Weight	[kg]	1.3	2.9	5.4	7.9
Hydraulic					
Max. operating pressure	[bar]	350	350	350	210
Max. Flow	[l/min]	80	160	200	341
Opening pressure	[bar]	0.5	0.5	0.3	0.3
Meter-in throttle		•	•	•	—
Meter-out throttle		•	•	•	•
Fluid		Hydraulic oil according to DIN 51524			
Fluid temperature	[°C]	-20...+70			
Viscosity	permitted	[cSt] / [mm²/s] 20...400			
	recommended	[cSt] / [mm²/s] 30...80			
Filtration		ISO 4406; 18/16/13			

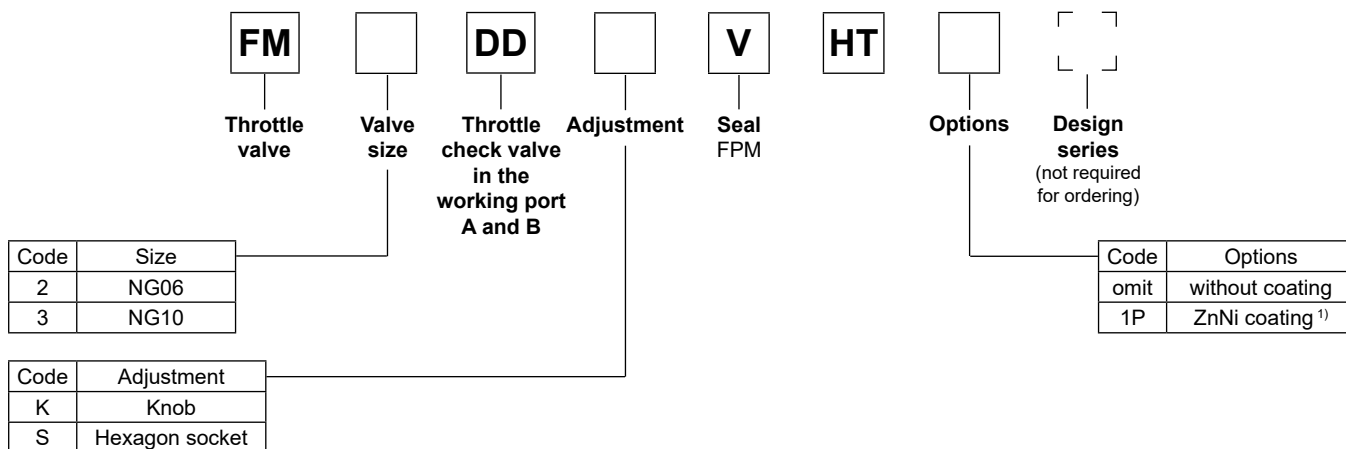

**7**

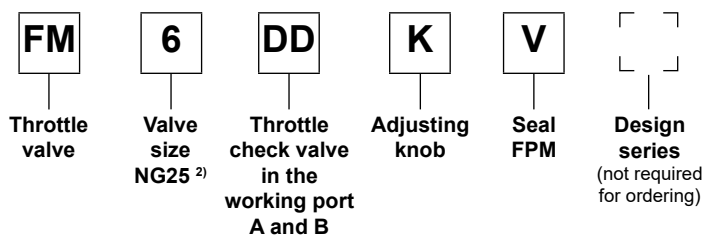
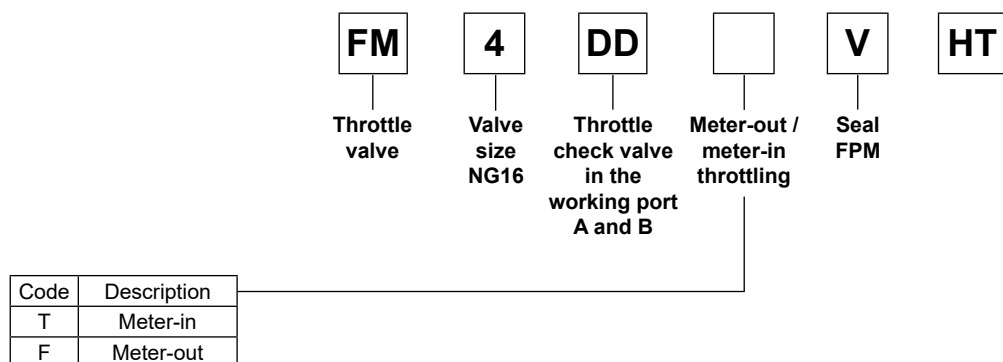

<sup>1)</sup> On request.

<sup>2)</sup> Only meter-out available.

**FM2 standard needle**

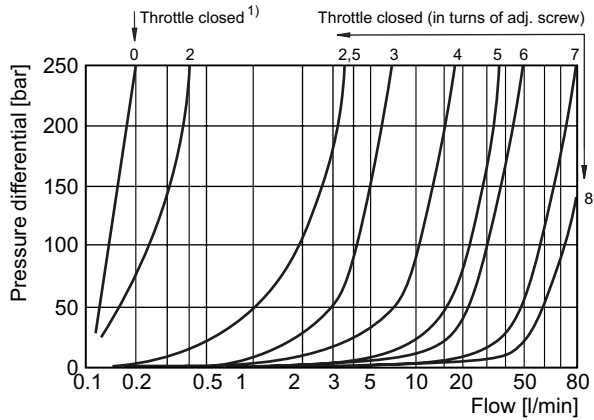

<sup>1)</sup>Leakage 0.1 ... 0.2 l/min

**FM2 flow, check valve**

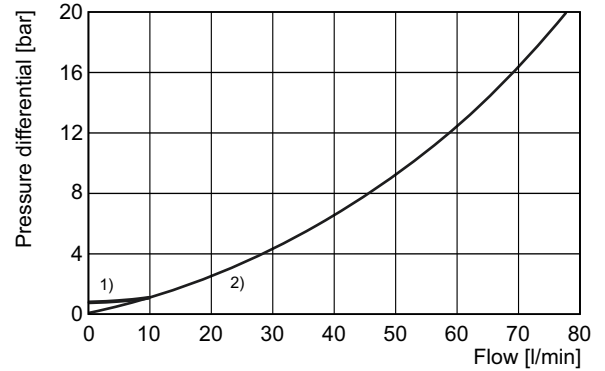

<sup>1)</sup>through check valve: throttle closed  
<sup>2)</sup>through check valve: throttle open

**FM3 standard needle**

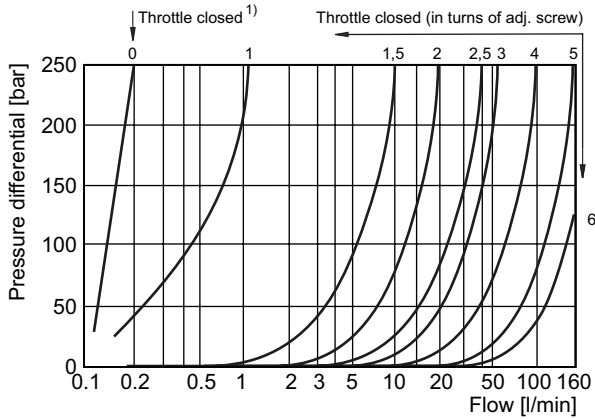

<sup>1)</sup>Leakage 0.1 ... 0.2 l/min

**FM3 flow, check valve**

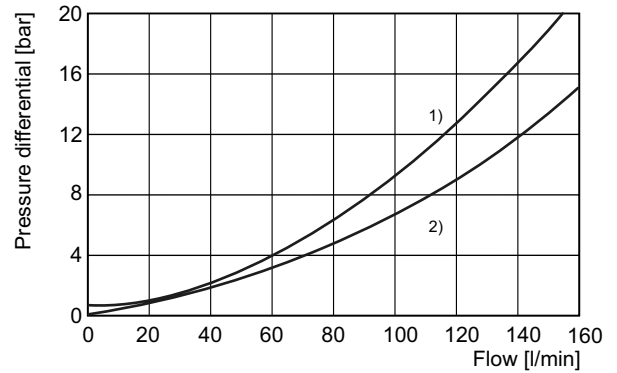

<sup>1)</sup>through check valve: throttle closed  
<sup>2)</sup>through check valve: throttle open

**7**

All characteristic curves measured with HLP46 at 50 °C.

FM UK.indd 03.05.23

**FM4 with standard needle**

1 to 5 number of needle rotations

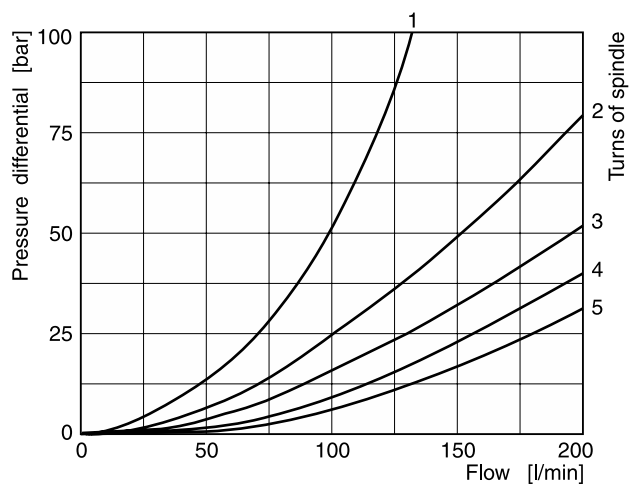

**FM4 flow, check valve**

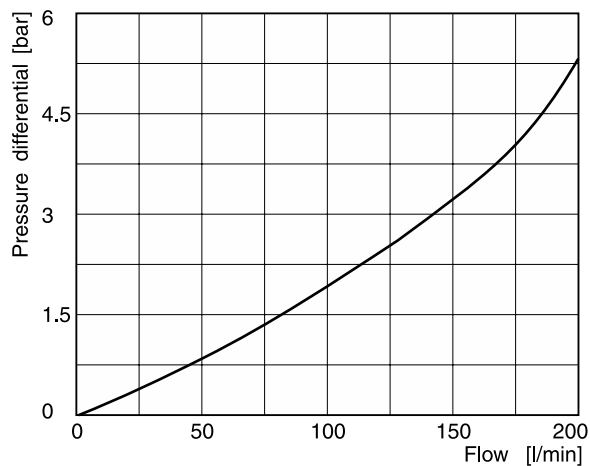

**FM6 with standard needle**

1 to 5 number of needle rotations

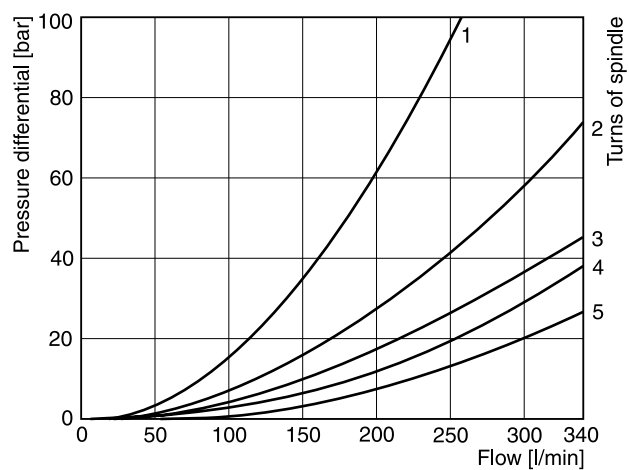

**FM6 flow, check valve**

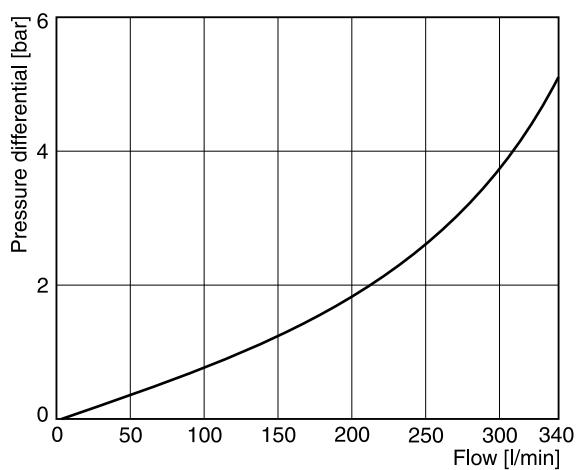

7

All characteristic curves measured with HLP46 at 50 °C.

FM UK.indd 03.05.23

**FM2**

**Meter-out**

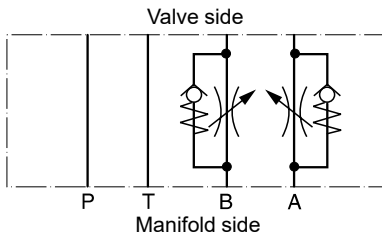

**Meter-in or meter-out**

A functional change is achieved by rotating the mounting position of the valve 180° about the longitudinal axis (A-B).

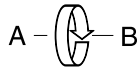

**Meter-in**

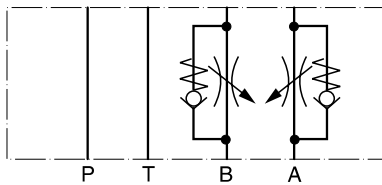

**Adjustment code S**

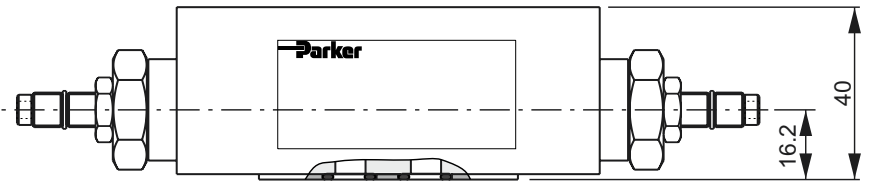
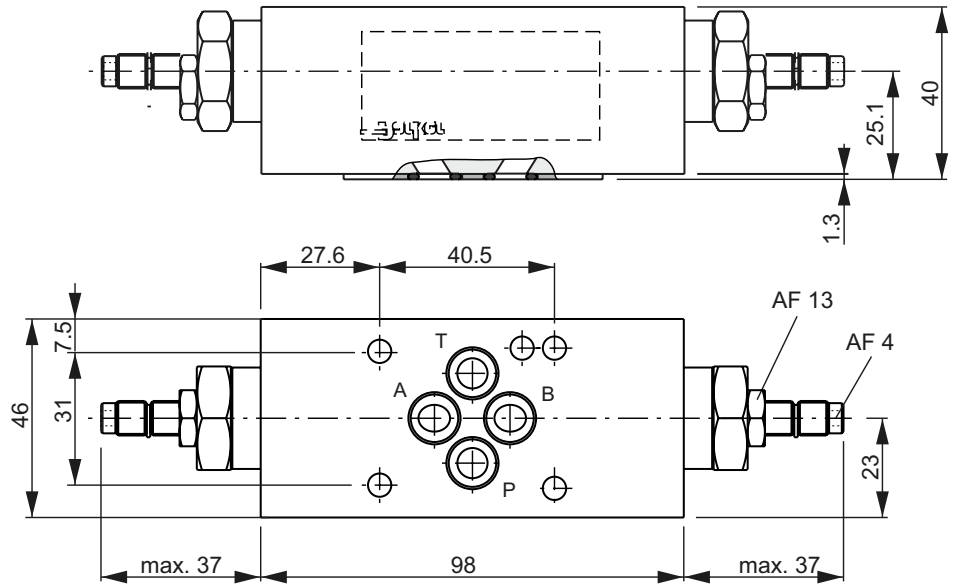

**Adjustment code K**

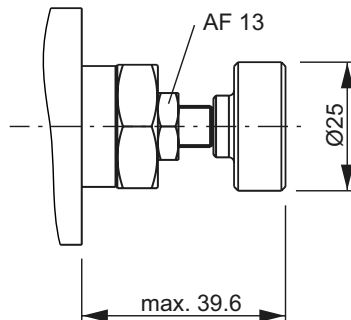

Seal kit FM2	
Seal	Order code
V	SK-FM2-V-20

**Note:**

The O-ring plate (with O-rings) for sealing the connecting surface of the manifold side is included. The O-ring plate is always mounted on the manifold side.

**7**

**FM3**

**Meter-out**

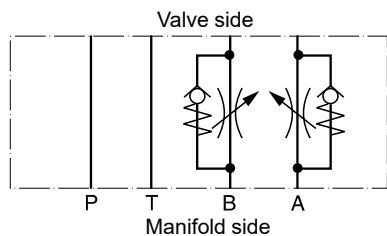

**Meter-in or meter-out**

A functional change is achieved by rotating the mounting position of the valve 180° about the transverse axis (P).



**Meter-in**

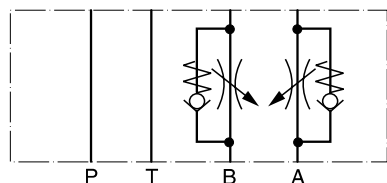

**Adjustment code S**

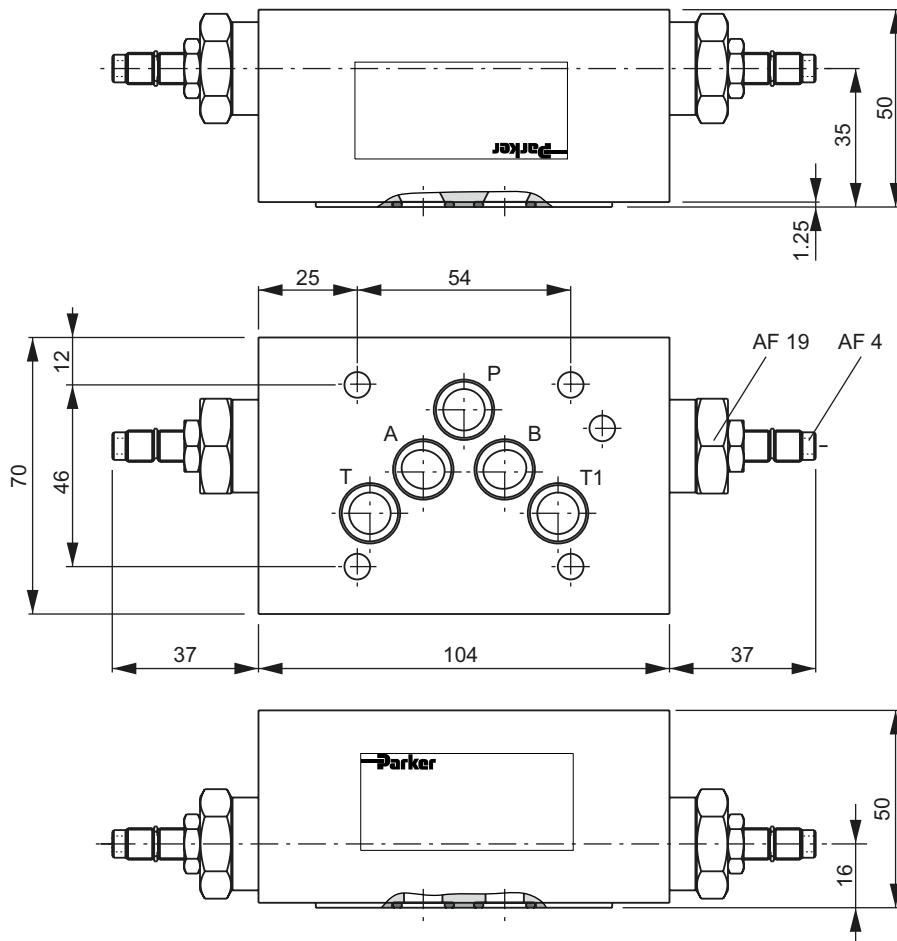

**Adjustment code K**

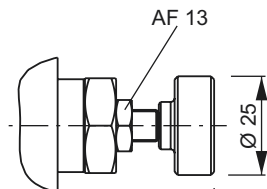

Seal kit FM3	
Seal	Order code
V	SK-FM3-V-51

**Note:**

The O-ring plate (with O-rings) for sealing the connecting surface of the manifold side is included. The O-ring plate is always mounted on the manifold side.

**FM4**

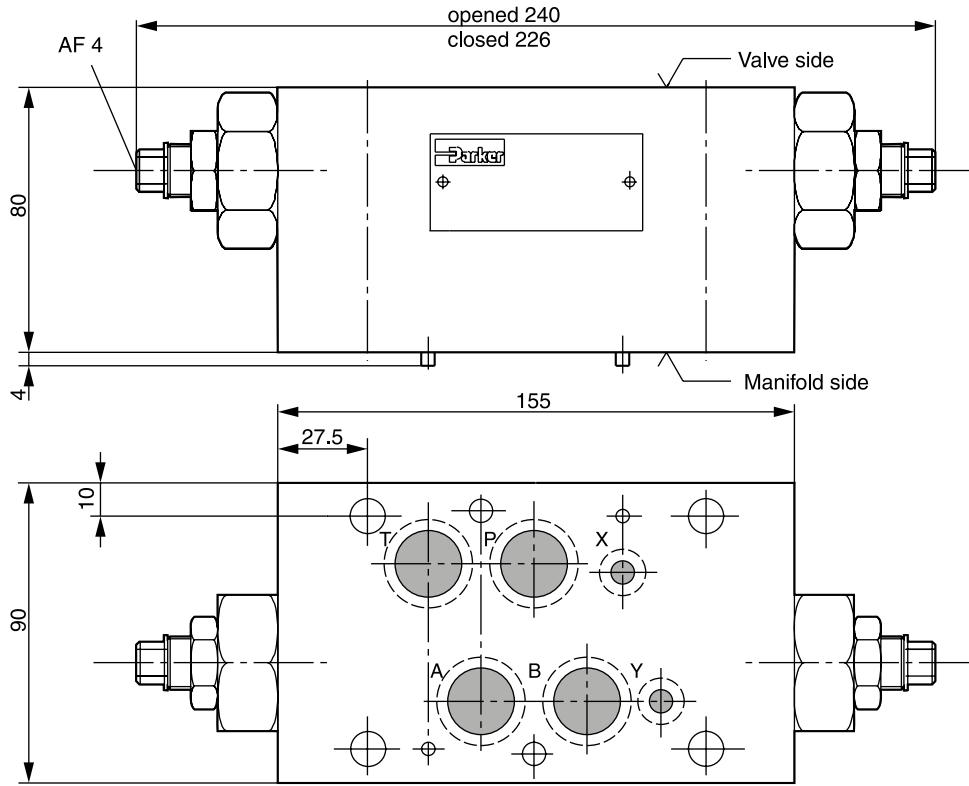

7

**Meter-in**

**Meter-out**

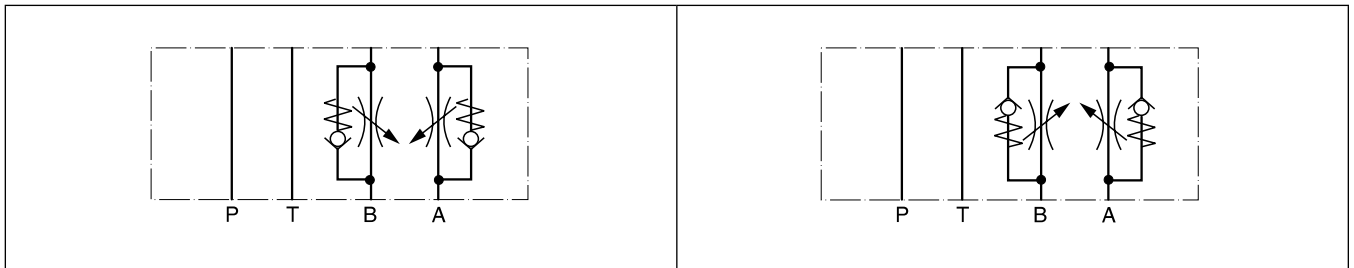

Seal kit FM4	
Seal	Order code
V	SK-FM4VHT

**FM6**

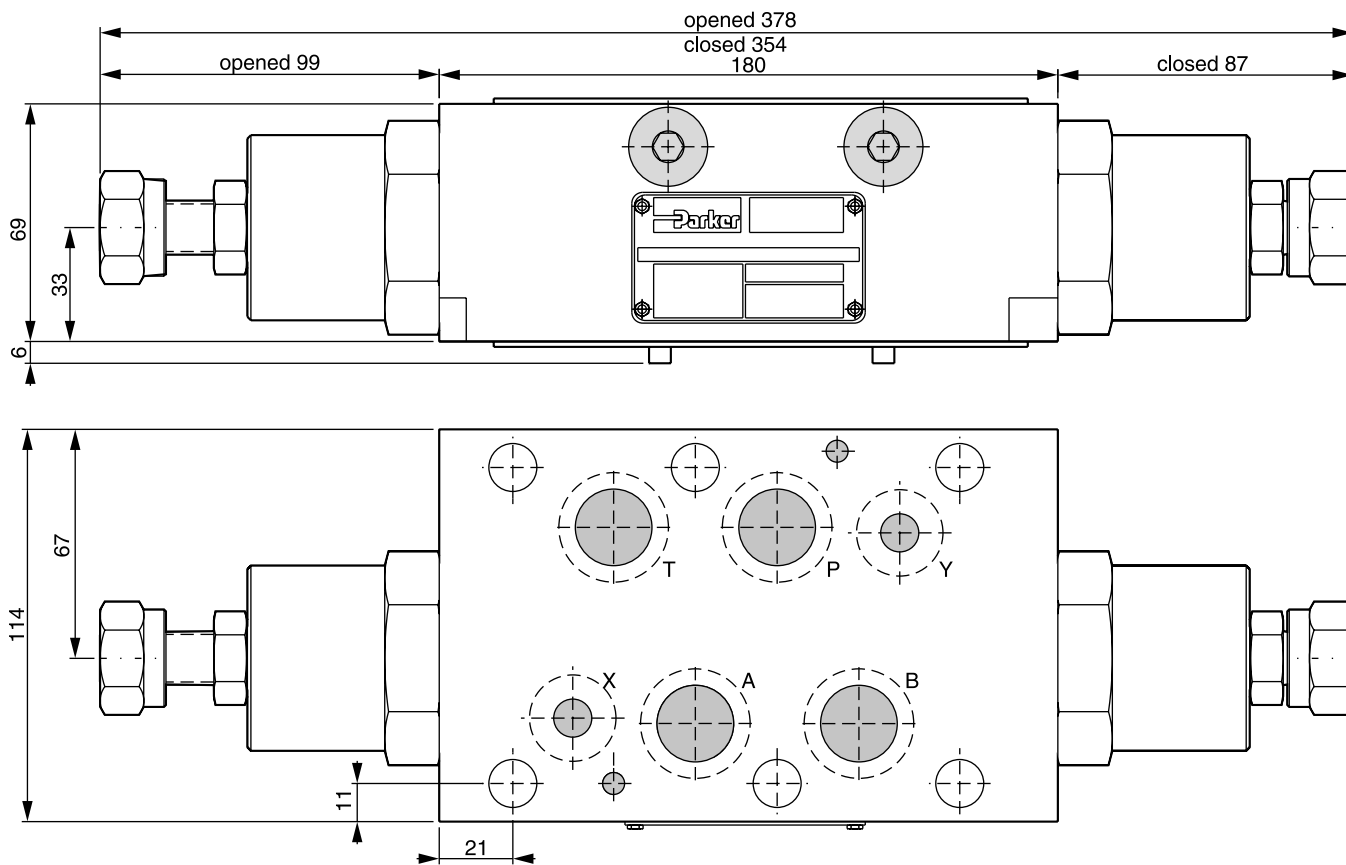

7

**Meter-out**

Adjustment: knob

Meter-in is not available for FM6

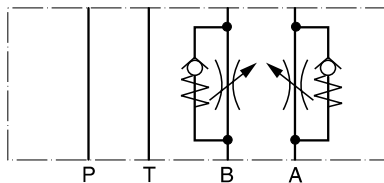

Seal kit FM6	
Seal	Order code
V	SK-FM6-V-12